

The Soraa Arc™ Adjustable combines elegant design with Soraa's unique quality of light to create a dynamic and versatile solution for retail, hospitality, and residential applications. Soraa Arc gets its name from its unique die-cast curved heat sink, which features a form carefully engineered for optimal thermal performance. Soraa Arc is compatible with the Soraa SNAP System™, which allows you to shape beams, shift color, and more - in a snap.

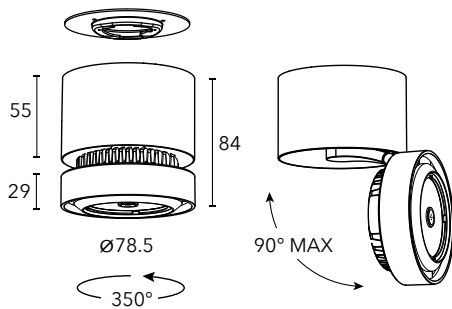

Soraa VIVID™ LED

Soraa Full Spectrum integral LED Light Engine available in 2700K, 3000K, and 4000K with 95 CRI and 95 R9. IR and UV free.

Soraa Optics

Soraa optic technology with exceptional beam control and smooth uniform light distribution. The 10° and 15° beam versions are compatible with Soraa SNAP System accessories.

Construction and Finish

Light engine is made of die cast aluminium, transformer case from extruded aluminum. Durable satin finish. Custom colors available. Tilt: 0-90°, rotation: 350°.

Applications

Suitable for damp or dry locations. For interior use only.

Installation

Surface mounting with trim ring (included) attached to ceiling.

Electrical

220-240VAC integrated electronic constant current LED driver (included).
Frequency: 50/60Hz
Power Factor: 0.93
Wattage: 11W,18W
Protection: Class 1

Dimming

Dimmable to <1%
Phase dimming standard
Visit www.soraa.com for details

Operating Temperature

Minimum -40°C, 25°C typical.

Accessories

Luminaire accommodates both Arc accessories and Soraa SNAP System simultaneously.

Compliance

CE Compliant. Rated for damp locations.

Warranty

Five year warranty. See www.soraa.com.

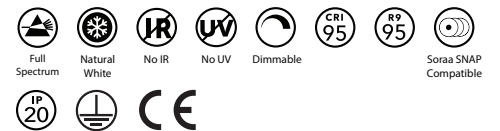
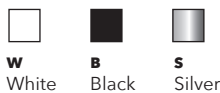

Build Your Luminaire Sample Number: ARA50-25D-927-E-S-W-S3

| Series | Beam & Wattage | CCT | Driver | Mounting | Finish | Region |
|---|-----------------------------------|------------------|--|------------------|--|--------------------|
| ARA50 Soraa Arc Adjustable, 50mm | 10D 10° Narrow Spot - 11W | 927 2700K | ED 220-240VAC DALI | S Surface | B Black W White S Silver C Custom | S3 EU, APAC |
| | 15D 15° Narrow Spot - 18W | 930 3000K | EH1 220-240VAC Triac & ELV, 0-10V | | | |
| | 25D 25° Narrow Flood - 18W | 940 4000K | | | | |
| | 36D 36° Flood - 18W | | | | | |

Photometrics - Soraa Arc™ 50mm

Data is shown for 3000K, for 2700K multiply Lux by 0.95, for 4000K by 1.04.

Narrow Spot 10°

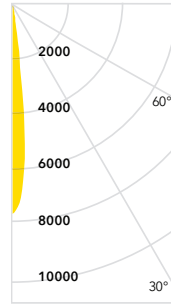

| W | CCT | Lm | CBCP |
|----|------|-----|---------|
| 11 | 2700 | 505 | 7360 cd |
| 11 | 3000 | 535 | 7800 cd |
| 11 | 4000 | 555 | 8090 cd |

Candelas at Nadir

| | |
|-----|------|
| 0° | 8139 |
| 5° | 5415 |
| 15° | 248 |
| 25° | 91 |
| 35° | 54 |
| 45° | 25 |



Spot 15°

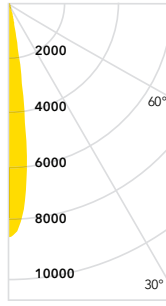

| W | CCT | Lm | CBCP |
|----|------|-----|---------|
| 18 | 2700 | 880 | 7650 cd |
| 18 | 3000 | 930 | 8080 cd |
| 18 | 4000 | 965 | 8380 cd |

Candelas at Nadir

| | |
|-----|------|
| 0° | 8165 |
| 5° | 6573 |
| 15° | 628 |
| 25° | 151 |
| 35° | 87 |
| 45° | 46 |



Narrow Flood 25°

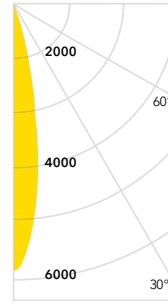

| W | CCT | Lm | CBCP |
|----|------|------|---------|
| 18 | 2700 | 950 | 5510 cd |
| 18 | 3000 | 1000 | 5800 cd |
| 18 | 4000 | 1040 | 6030 cd |

Candelas at Nadir

| | |
|-----|------|
| 0° | 5870 |
| 5° | 4970 |
| 15° | 1562 |
| 25° | 128 |
| 35° | 37 |
| 45° | 25 |

Flood 36°

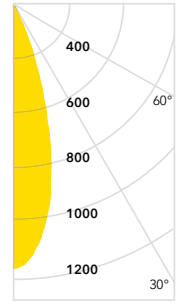

| W | CCT | Lm | CBCP |
|----|------|------|---------|
| 18 | 2700 | 950 | 2560 cd |
| 18 | 3000 | 1000 | 2700 cd |
| 18 | 4000 | 1040 | 2800 cd |

Candelas at Nadir

| | |
|-----|------|
| 0° | 2771 |
| 5° | 2683 |
| 15° | 1627 |
| 25° | 408 |
| 35° | 82 |
| 45° | 32 |

Aiming Angles

L and W refer to outer points where lux drops to 50% of maximum. LX refers to initial lux at the center of the beam.

Key (distances in metres)

- L** Beam Distance
- D** Distance
- W** Beam Width
- LX** Lux
- C** Distance to Center Beam

0° Horizontal

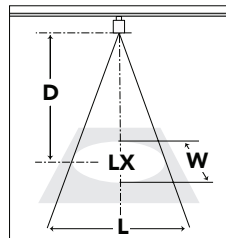

30° Horizontal

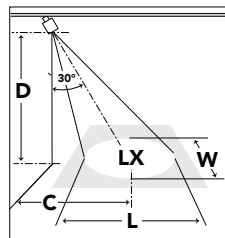

30° Vertical

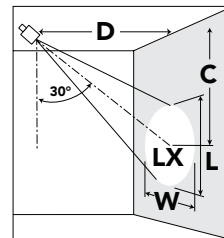

60° Vertical

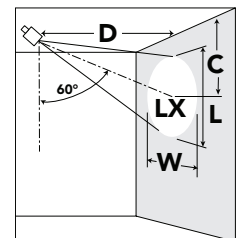

| | D | LX | L | W | D | C | LX | L | W | D | C | LX | L | W | D | C | LX | L | W |
|------------------------------|-----|------|-----|-----|-----|-----|------|-----|-----|-----|-----|------|-----|-----|-----|-----|-------|-----|-----|
| Narrow Spot 10° (11W) | 1.8 | 2400 | 0.4 | 0.4 | 1.8 | 1.1 | 1593 | 1.6 | 1.4 | 0.6 | 1.1 | 3089 | 1.4 | 0.7 | 0.6 | 0.4 | 13197 | 0.2 | 0.5 |
| | 2.4 | 1367 | 0.5 | 0.5 | 2.4 | 1.5 | 915 | 2.2 | 1.9 | 0.9 | 1.6 | 1399 | 2.1 | 1.0 | 0.9 | 0.6 | 6243 | 0.2 | 0.7 |
| | 3.0 | 883 | 0.6 | 0.6 | 3.0 | 1.8 | 581 | 2.7 | 2.3 | 1.2 | 2.1 | 807 | 2.7 | 1.4 | 1.2 | 0.8 | 3552 | 0.3 | 1.0 |
| | 3.7 | 624 | 0.8 | 0.8 | 3.7 | 2.1 | 420 | 3.2 | 2.8 | 1.5 | 2.6 | 517 | 3.4 | 1.7 | 1.5 | 1.0 | 2282 | 0.4 | 1.2 |
| Spot 15° | 1.8 | 2433 | 0.5 | 0.5 | 1.8 | 1.1 | 1625 | 2.1 | 1.8 | 0.6 | 1.1 | 3305 | 1.7 | 0.9 | 0.6 | 0.4 | 13713 | 0.2 | 0.6 |
| | 2.4 | 1367 | 0.6 | 0.6 | 2.4 | 1.5 | 926 | 2.8 | 2.3 | 0.9 | 1.6 | 1507 | 2.5 | 1.3 | 0.9 | 0.6 | 6361 | 0.3 | 0.9 |
| | 3.0 | 883 | 0.8 | 0.8 | 3.0 | 1.8 | 592 | 3.4 | 2.9 | 1.2 | 2.2 | 850 | 3.3 | 1.8 | 1.2 | 0.8 | 3606 | 0.4 | 1.2 |
| | 3.7 | 614 | 0.9 | 0.9 | 3.7 | 2.1 | 420 | 4.1 | 3.5 | 1.5 | 2.7 | 549 | 4.1 | 2.1 | 1.5 | 1.0 | 2325 | 0.5 | 1.5 |
| Narrow Flood 25° | 1.8 | 1765 | 0.7 | 0.7 | 1.8 | 1.1 | 1173 | 2.9 | 2.5 | 0.6 | 1.2 | 2573 | 2.1 | 1.2 | 0.6 | 0.4 | 10150 | 0.3 | 0.9 |
| | 2.4 | 1001 | 0.9 | 0.9 | 2.4 | 1.5 | 667 | 3.8 | 3.3 | 0.9 | 1.7 | 1163 | 3.1 | 1.8 | 0.9 | 0.6 | 4618 | 0.4 | 1.3 |
| | 3.0 | 657 | 1.1 | 1.1 | 3.0 | 1.8 | 441 | 4.6 | 4.1 | 1.2 | 2.3 | 667 | 4.1 | 2.4 | 1.2 | 0.8 | 2626 | 0.6 | 1.7 |
| | 3.7 | 463 | 1.3 | 1.3 | 3.7 | 2.2 | 301 | 5.5 | 4.9 | 1.5 | 2.8 | 431 | 5.1 | 2.9 | 1.5 | 0.9 | 1679 | 0.7 | 2.1 |
| Flood 36° | 1.8 | 840 | 1.0 | 1.0 | 1.8 | 1.2 | 614 | 3.8 | 3.5 | 0.6 | 1.3 | 1636 | 2.1 | 1.5 | 0.6 | 0.4 | 5274 | 0.4 | 1.2 |
| | 2.4 | 484 | 1.3 | 1.3 | 2.4 | 1.5 | 344 | 5.0 | 4.6 | 0.9 | 1.8 | 732 | 3.2 | 2.2 | 0.9 | 0.6 | 2379 | 0.6 | 1.8 |
| | 3.0 | 312 | 1.6 | 1.6 | 3.0 | 1.9 | 226 | 6.2 | 5.5 | 1.2 | 2.3 | 420 | 4.2 | 3.0 | 1.2 | 0.8 | 1356 | 0.8 | 2.4 |
| | 3.7 | 226 | 1.9 | 1.9 | 3.7 | 2.2 | 161 | 7.5 | 6.6 | 1.5 | 2.8 | 269 | 5.1 | 3.6 | 1.5 | 1.0 | 883 | 0.9 | 2.9 |

Soraa Arc™ Color and Whiteness Rendering

| CCT | CRI | R9 | Rf | Rg | Rfh1 | Rw | McA |
|------|-----|----|----|-----|------|-----|-----|
| 2700 | 95 | 95 | 90 | 100 | 95 | 120 | 3 |
| 3000 | 95 | 95 | 90 | 100 | 95 | 120 | 3 |
| 4000 | 95 | 95 | 90 | 100 | 95 | 70 | 4 |

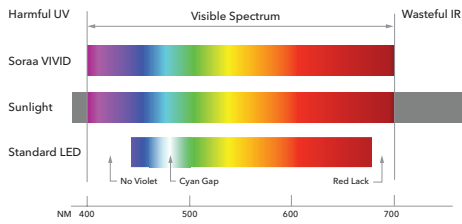

Soraa has engineered the perfect balance between color rendering and white rendering. Soraa's core technology uses a violet LED emitter as the basis for full spectrum light. This allows both Vivid™ color rendering and Natural White™ white rendering, which creates whiteness by exciting fluorescing agents with violet radiation, without the harmful effect of UV.

Rf: The TM-30 metric for color fidelity (similarity to colors under natural light), a more accurate version of the CRI Ra. Rf is 100 for natural light.

Rg: The TM-30 metric for color gamut (whether colors are more saturated than under natural light). Rg is 100 for natural light.

Rfh1: The TM-30 metric for color fidelity for red tones. Rfh1 is a more accurate version of the CRI R9. Rfh1 is 100 for natural light.

Rw: The Soraa-developed metric for white fidelity. Rw measures the magnitude of excitation of whitening agents within white materials. Rw is 100 for natural light.

2700K

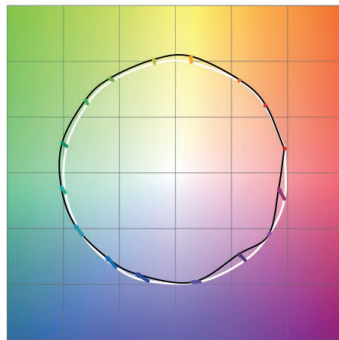

Rf: 90, Rg: 100, Rfh1: 95

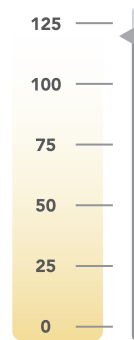

Rw: 120

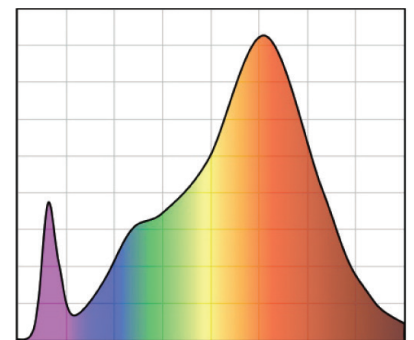

CRI: 95, R9: 95

3000K

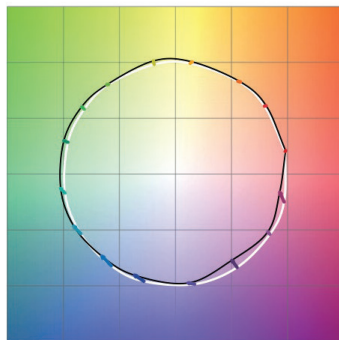

Rf: 90, Rg: 100, Rfh1: 95

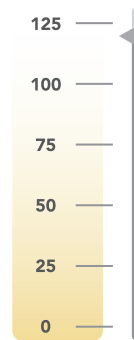

Rw: 120

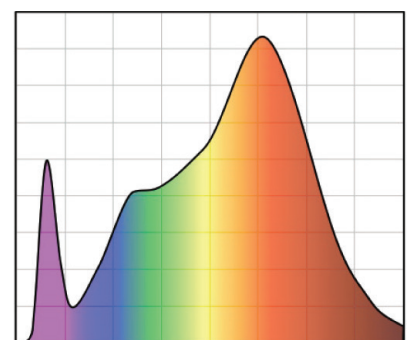

CRI: 95, R9: 95

4000K

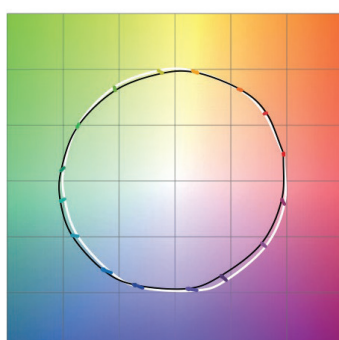

Rf: 90, Rg: 100, Rfh1: 95

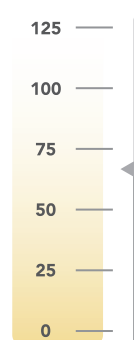

Rw: 70

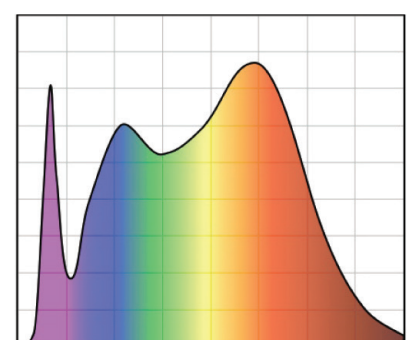

CRI: 95, R9: 95