

The Soraa Arc™ Adjustable combines elegant design with Soraa's unique quality of light to create a dynamic and versatile solution for retail, hospitality, and residential applications. Soraa Arc gets its name from its unique die-cast curved heat sink, which features a form carefully engineered for optimal thermal performance. Soraa Arc is compatible with the Soraa SNAP System™, which allows you to shape beams, shift color, and more - in a snap.

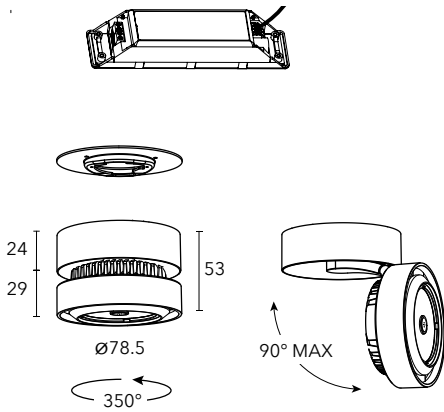

Soraa VIVID™ LED

Soraa Full Spectrum integral LED Light Engine available in 2700K, 3000K, and 4000K with 95 CRI and 95 R9. IR and UV free.

Soraa Optics

Soraa optic technology with exceptional beam control and smooth uniform light distribution. The 10° and 15° beam versions are compatible with Soraa SNAP System accessories.

Construction and Finish

Light engine is made of die cast aluminium, transformer case from extruded aluminum. Durable satin finish. Custom colors available. Tilt: 0-90°, rotation: 350°.

Applications

Suitable for damp or dry locations. For interior use only.

Installation

Semi-recessed mounting with trim ring (included) attached to ceiling and remote driver (included). 53mm (2.08") ceiling opening recommended.

Electrical

220-240VAC electronic constant current LED driver (included).
 Frequency: 50/60Hz
 Power Factor: 0.93
 Wattage: 11W,18W
 Protection: Class 3

Dimming

Dimmable to <1%
 Phase dimming standard
 Visit www.soraa.com for details

Operating Temperature

Minimum -40°C, 25°C typical.

Accessories

Luminaire accommodates both Arc accessories and Soraa SNAP System simultaneously.

Compliance

CE Compliant. Rated for damp locations.

Warranty

Five year warranty. See www.soraa.com.

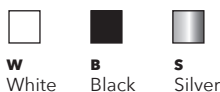

Build Your Luminaire Sample Number: ARA50-25D-927-E-SR-W-S3

Series	Beam & Wattage	CCT	Driver	Mounting	Finish	Region
ARA50 Soraa Arc Adjustable, 50mm	10D 10° Narrow Spot - 11W	927 2700K	E 220-240VAC Phase Dim	SR Semi Recessed	B Black	S3 EU, APAC
	15D 15° Narrow Spot - 18W	930 3000K	ED 220-240VAC DALI		W White	
	25D 25° Narrow Flood - 18W	940 4000K	E10 220-240VAC 0-10V		S Silver	
	36D 36° Flood - 18W				C Custom	

Photometrics - Soraa Arc™ 50mm

Data is shown for 3000K, for 2700K multiply Lux by 0.95, for 4000K by 1.04.

Narrow Spot 10°

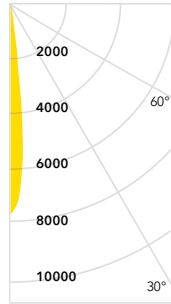

W	CCT	Lm	CBCP
11	2700	505	7360 cd
11	3000	535	7800 cd
11	4000	555	8090 cd

Candelas at Nadir

0°	8139
5°	5415
15°	248
25°	91
35°	54
45°	25



Soraa SNAP
Compatible

Spot 15°

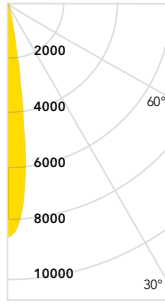

W	CCT	Lm	CBCP
18	2700	880	7650 cd
18	3000	930	8080 cd
18	4000	965	8380 cd

Candelas at Nadir

0°	8165
5°	6573
15°	628
25°	151
35°	87
45°	46



Soraa SNAP
Compatible

Narrow Flood 25°

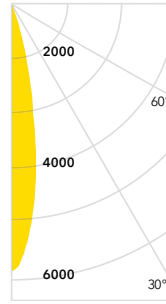

W	CCT	Lm	CBCP
18	2700	950	5510 cd
18	3000	1000	5800 cd
18	4000	1040	6030 cd

Candelas at Nadir

0°	5870
5°	4970
15°	1562
25°	128
35°	37
45°	25

Flood 36°

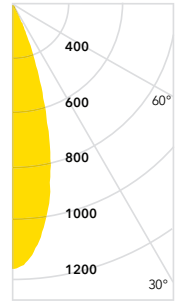

W	CCT	Lm	CBCP
18	2700	950	2560 cd
18	3000	1000	2700 cd
18	4000	1040	2800 cd

Candelas at Nadir

0°	2771
5°	2683
15°	1627
25°	408
35°	82
45°	32

Aiming Angles

L and W refer to outer points where lux drops to 50% of maximum. LX refers to initial lux at the center of the beam.

Key (distances in metres)

- L** Beam Distance
- D** Distance
- W** Beam Width
- LX** Lux
- C** Distance to Center Beam

0° Horizontal

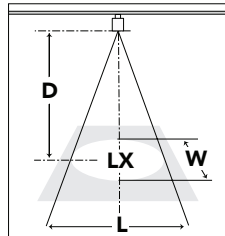

30° Horizontal

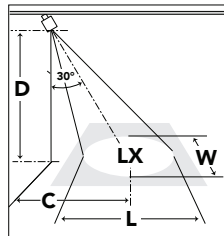

30° Vertical

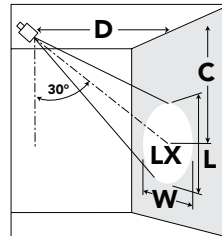

60° Vertical

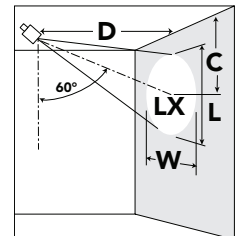

	D	LX	L	W	D	C	LX	L	W	D	C	LX	L	W	D	C	LX	L	W
Narrow Spot 10° (11W)	1.8	2400	0.4	0.4	1.8	1.1	1593	1.6	1.4	0.6	1.1	3089	1.4	0.7	0.6	0.4	13197	0.2	0.5
	2.4	1367	0.5	0.5	2.4	1.5	915	2.2	1.9	0.9	1.6	1399	2.1	1.0	0.9	0.6	6243	0.2	0.7
	3.0	883	0.6	0.6	3.0	1.8	581	2.7	2.3	1.2	2.1	807	2.7	1.4	1.2	0.8	3552	0.3	1.0
	3.7	624	0.8	0.8	3.7	2.1	420	3.2	2.8	1.5	2.6	517	3.4	1.7	1.5	1.0	2282	0.4	1.2
Spot 15°	1.8	2433	0.5	0.5	1.8	1.1	1625	2.1	1.8	0.6	1.1	3305	1.7	0.9	0.6	0.4	13713	0.2	0.6
	2.4	1367	0.6	0.6	2.4	1.5	926	2.8	2.3	0.9	1.6	1507	2.5	1.3	0.9	0.6	6361	0.3	0.9
	3.0	883	0.8	0.8	3.0	1.8	592	3.4	2.9	1.2	2.2	850	3.3	1.8	1.2	0.8	3606	0.4	1.2
	3.7	614	0.9	0.9	3.7	2.1	420	4.1	3.5	1.5	2.7	549	4.1	2.1	1.5	1.0	2325	0.5	1.5
Narrow Flood 25°	1.8	1765	0.7	0.7	1.8	1.1	1173	2.9	2.5	0.6	1.2	2573	2.1	1.2	0.6	0.4	10150	0.3	0.9
	2.4	1001	0.9	0.9	2.4	1.5	667	3.8	3.3	0.9	1.7	1163	3.1	1.8	0.9	0.6	4618	0.4	1.3
	3.0	657	1.1	1.1	3.0	1.8	441	4.6	4.1	1.2	2.3	667	4.1	2.4	1.2	0.8	2626	0.6	1.7
	3.7	463	1.3	1.3	3.7	2.2	301	5.5	4.9	1.5	2.8	431	5.1	2.9	1.5	0.9	1679	0.7	2.1
Flood 36°	1.8	840	1.0	1.0	1.8	1.2	614	3.8	3.5	0.6	1.3	1636	2.1	1.5	0.6	0.4	5274	0.4	1.2
	2.4	484	1.3	1.3	2.4	1.5	344	5.0	4.6	0.9	1.8	732	3.2	2.2	0.9	0.6	2379	0.6	1.8
	3.0	312	1.6	1.6	3.0	1.9	226	6.2	5.5	1.2	2.3	420	4.2	3.0	1.2	0.8	1356	0.8	2.4
	3.7	226	1.9	1.9	3.7	2.2	161	7.5	6.6	1.5	2.8	269	5.1	3.6	1.5	1.0	883	0.9	2.9

Soraa Arc™ Color and Whiteness Rendering

CCT	CRI	R9	Rf	Rg	Rfh1	Rw	McA
2700	95	95	90	100	95	120	3
3000	95	95	90	100	95	120	3
4000	95	95	90	100	95	70	4

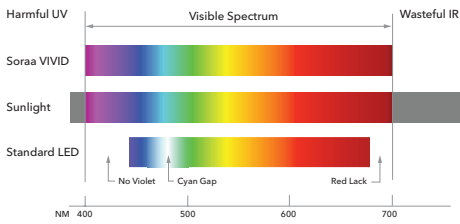

Soraa has engineered the perfect balance between color rendering and white rendering. Soraa's core technology uses a violet LED emitter as the basis for full spectrum light. This allows both Vivid™ color rendering and Natural White™ white rendering, which creates whiteness by exciting fluorescing agents with violet radiation, without the harmful effect of UV.

Rf: The TM-30 metric for color fidelity (similarity to colors under natural light), a more accurate version of the CRI Ra. Rf is 100 for natural light.

Rg: The TM-30 metric for color gamut (whether colors are more saturated than under natural light). Rg is 100 for natural light.

Rfh1: The TM-30 metric for color fidelity for red tones. Rfh1 is a more accurate version of the CRI R9. Rfh1 is 100 for natural light.

Rw: The Soraa-developed metric for white fidelity. Rw measures the magnitude of excitation of whitening agents within white materials. Rw is 100 for natural light.

2700K

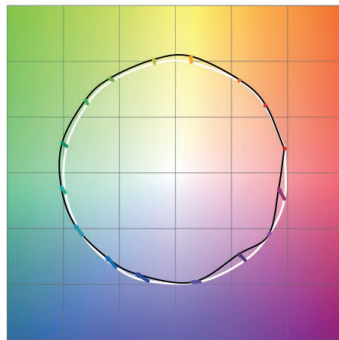

Rf: 90, Rg: 100, Rfh1: 95

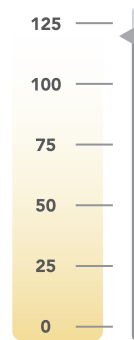

Rw: 120

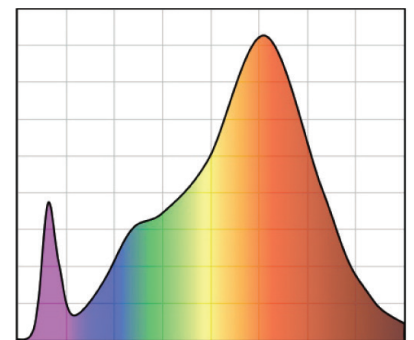

CRI: 95, R9: 95

3000K

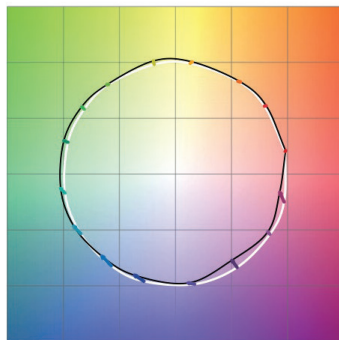

Rf: 90, Rg: 100, Rfh1: 95

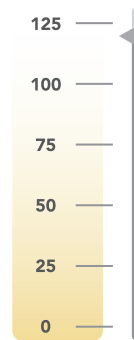

Rw: 120

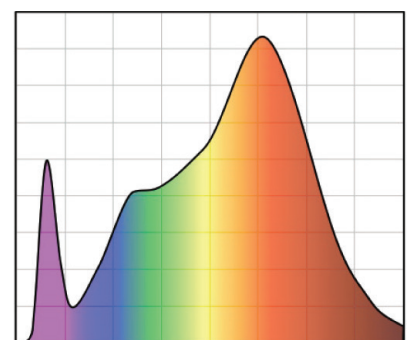

CRI: 95, R9: 95

4000K

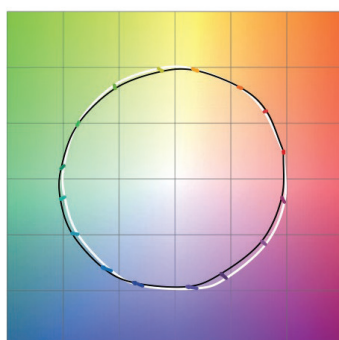

Rf: 90, Rg: 100, Rfh1: 95

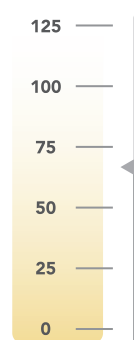

Rw: 70

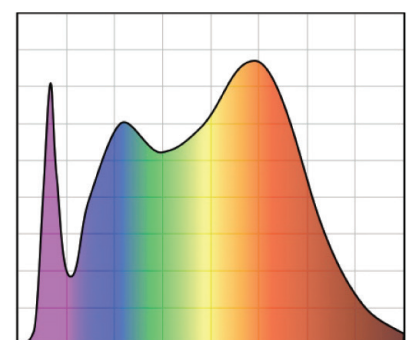

CRI: 95, R9: 95